

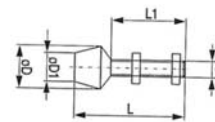

Vite di pressione

Vite di pressione con due dadi di fissaggio, in neoprene vulcanizzata, priva di resina (85°Shore), trattata termicamente, zincata e passivata, resistente alle temperature -20 °C fino a +80 °C.



Codice	€	G (M)	ø D (mm)	L (mm)	L1 (mm)	ø D1 (mm)
C603650005	---	6	16	44	30	12
C603650010	---	6	16	54	40	12
C603650015	---	8	21	53	35	14

Codice	€	G (M)	ø D (mm)	L (mm)	L1 (mm)	ø D1 (mm)
C603650020	---	8	21	63	45	14
C603650025	---	10	26	79	55	20
C603650030	---	12	30	102	73	24



Vite di pressione

Vite di pressione con 2 dadi esagonali trattati termicamente, zincati e passivati.

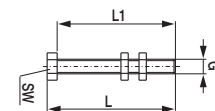

Codice	€	G (M)	L (mm)	L1 (mm)	SW (mm)
C603570105	---	6	49	45	10
C603570110	---	8	75,5	70	13
C603570115	---	10	77	70	16

Codice	€	G (M)	L (mm)	L1 (mm)	SW (mm)
C603570120	---	12	88	80	18
C603570125	---	16	130	120	24



Squadretta di fissaggio

Squadretta di fissaggio zincata e passivata.



Modello 1

Modello 2

Modello 3

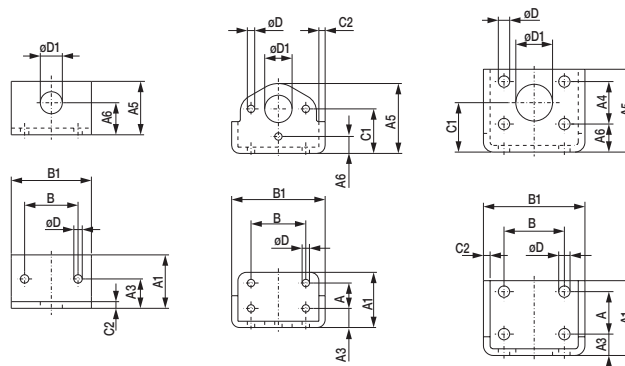

Modello 1

Modello 2

Modello 3

Codice	€	Esecuzione	A (mm)	A1 (mm)	A3 (mm)	A4 (mm)	A5 (mm)	A6 (mm)	B (mm)	B1 (mm)	C1 (mm)	C2 (mm)	øD (mm)	øD1 (mm)
C603580005	---	modello 1	-	39,9	22,1	-	39,9	24	39,9	59,9	-	5,1	6,6	16,5
C603580010	---	modello 2	19,1	40,6	14,5	-	52,6	12,4	41,1	71,1	33	4,6	5,6	19,1
C603580015	---	modello 3	32	55,9	16	32	62	21,1	45	76,2	37,1	5,1	8,4	27,4



Magnete permanente in lega alnico

Magnete permanente in lega alnico, schermato con anello in ottone, la schermatura garantisce una coercività magnetica maggiore, per permettergli di mantenere inalterate le sue caratteristiche anche se a contatto con componenti ferrosi, protezione esterna contro gli urti, resistenza al calore sino a 450 °C.

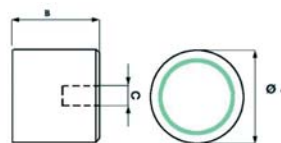

Codice	€	Pz	ø A (mm)	B (mm)	C	Forza di ritegno (Kg)
C606050005	---	1	9,5	15	M3	1,5
C606050127	---	10	12,7	15,8	M4	2
C606050175	---	5	17,5	15,8	M6	4
C606050206	---	5	20,6	19	M6	5,5
C606050270	---	5	27	25,4	M6	10

Codice	€	Pz	ø A (mm)	B (mm)	C	Forza di ritegno (Kg)
C606050350	---	5	35	20	M6	12
C606050351	---	5	35	30	M6	18
C606050450	---	2	45	30	M8	40
C606050500	---	2	50	40	M8	50
C606050550	---	2	55*	14	M8	10

*Magnete in ceramica resistenza al calore fino a 150 °C.